

.... It is then necessary to carry and lift
it in order to be able to use it ...

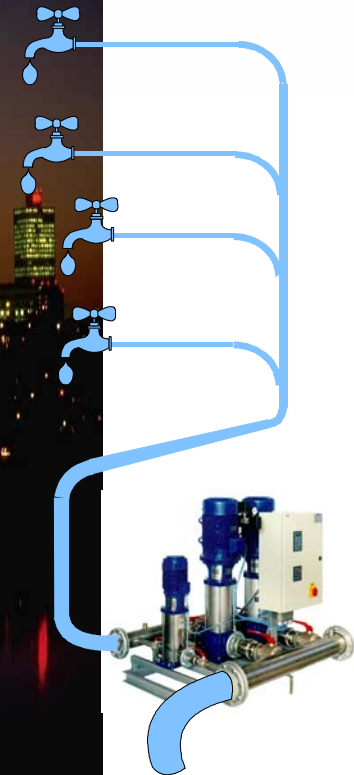

..IN ITS DIFFERENT VERSIONS..



.. is today the most employed machine for the carrying and lifting of water.



NOCCHI®

Pentair Water

25/285 RamKhamHaeng 124 Rd., Sapsansong Bangkok 10240 Thailand Tel : 0 2728 2902 Fax : 0 2728 1779 www.tinamics.com

Tinamics Co.,Ltd.



The electric control box, fed by an electric energy source

.. controls the working of the pump...

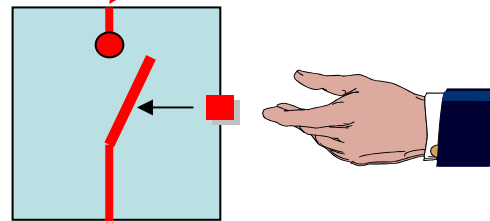
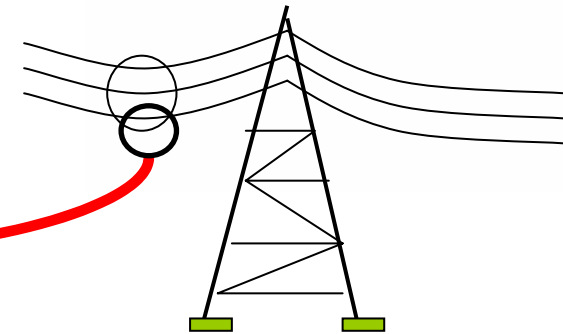

.... **MANUALLY** ...

... **or** ...

.. AUTOMATICALLY..

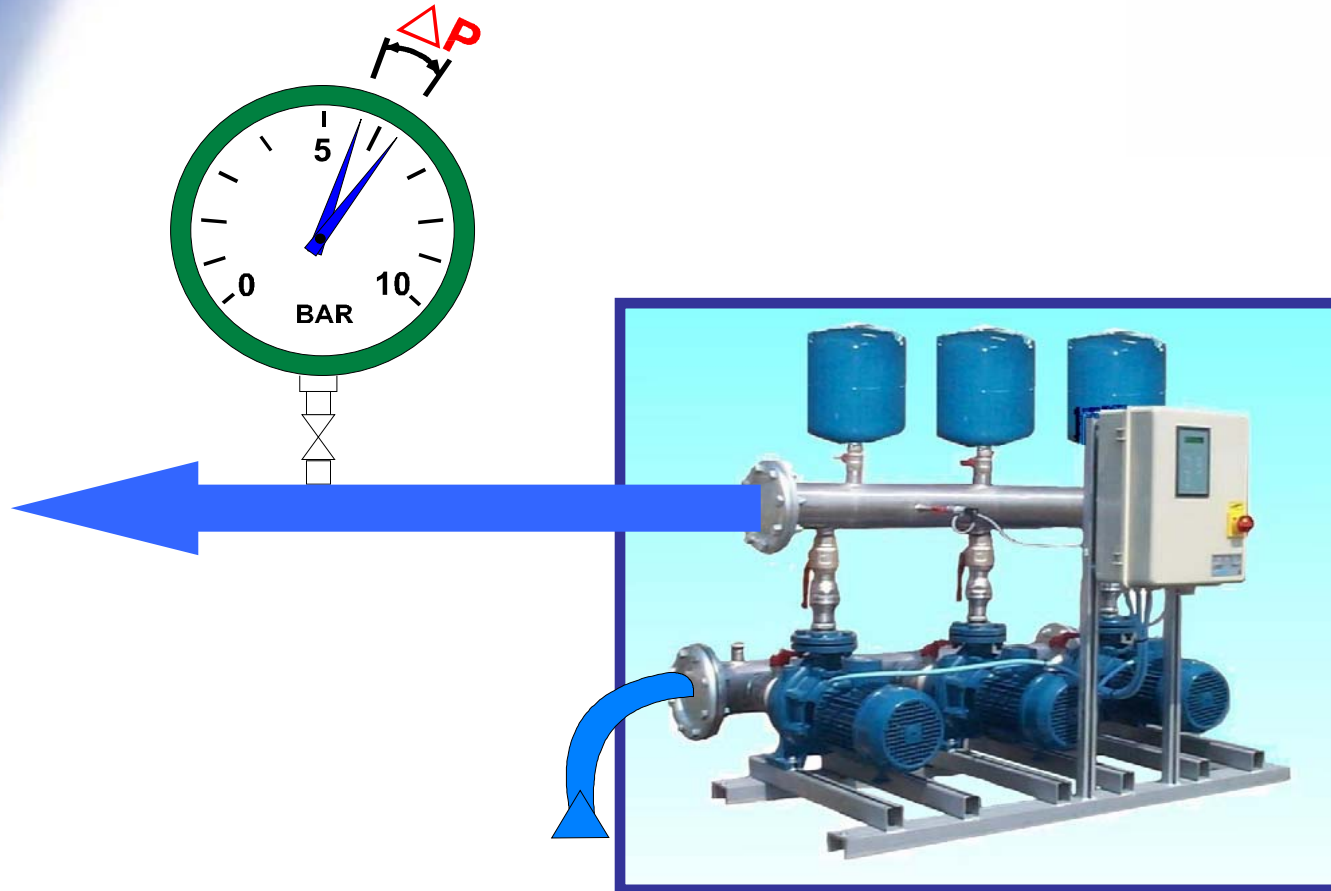

NOCCHI[®]

Pentair Water

25/285 RamKhamHaeng 124 Rd., Sapsong Bangkok 10240 Thailand Tel : 0 2728 2902 Fax : 0 2728 1779 www.tinamics.com

Tinamics Co.,Ltd.



BOOSTER SET

**Several pumps
working together
are employed for
considerable water
consumption**



NOCCHI[®]

Pentair Water

25/285 RamKhamHaeng 124 Rd., Sapansoong Bangkok 10240 Thailand Tel : 0 2728 2902 Fax : 0 2728 1779 www.tinamics.com

Tinamics Co.,Ltd.



WATER BOOSTER SET MAIN COMPONENTS

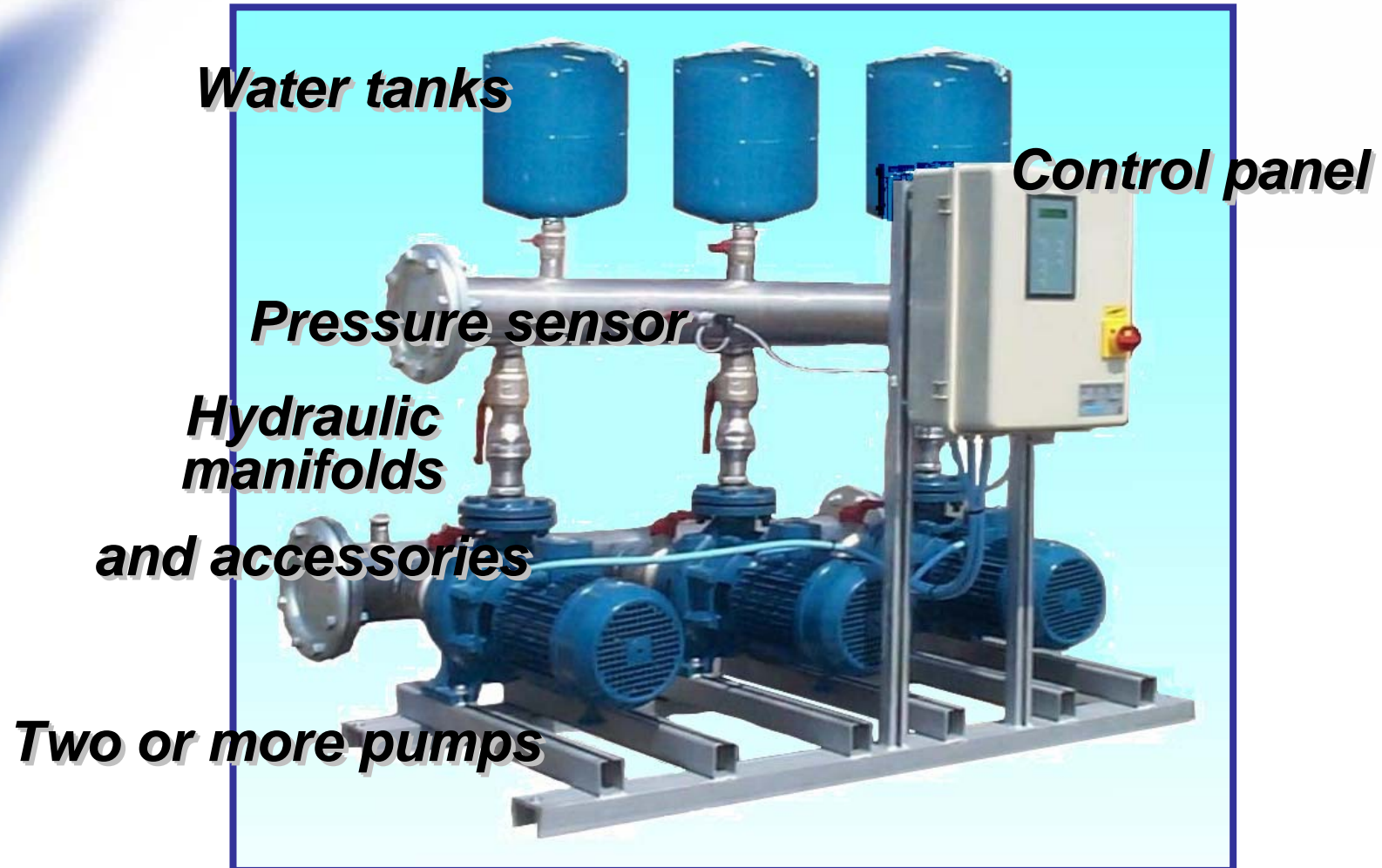

NOCCHI[®]

Pentair Water

25/285 RamKhamHaeng 124 Rd., Sapsanong Bangkok 10240 Thailand Tel : 0 2728 2902 Fax : 0 2728 1779 www.tinamics.com

Tinamics Co.,Ltd.



Water booster sets are used in :



.....ETC



NOCCHI®

Pentair Water

25/285 RamKhamHaeng 124 Rd., Sapansoong Bangkok 10240 Thailand Tel : 0 2728 2902 Fax : 0 2728 1779 www.tinamics.com

Tinamics Co.,Ltd.



PUMPS USED IN BOOSTER SETS

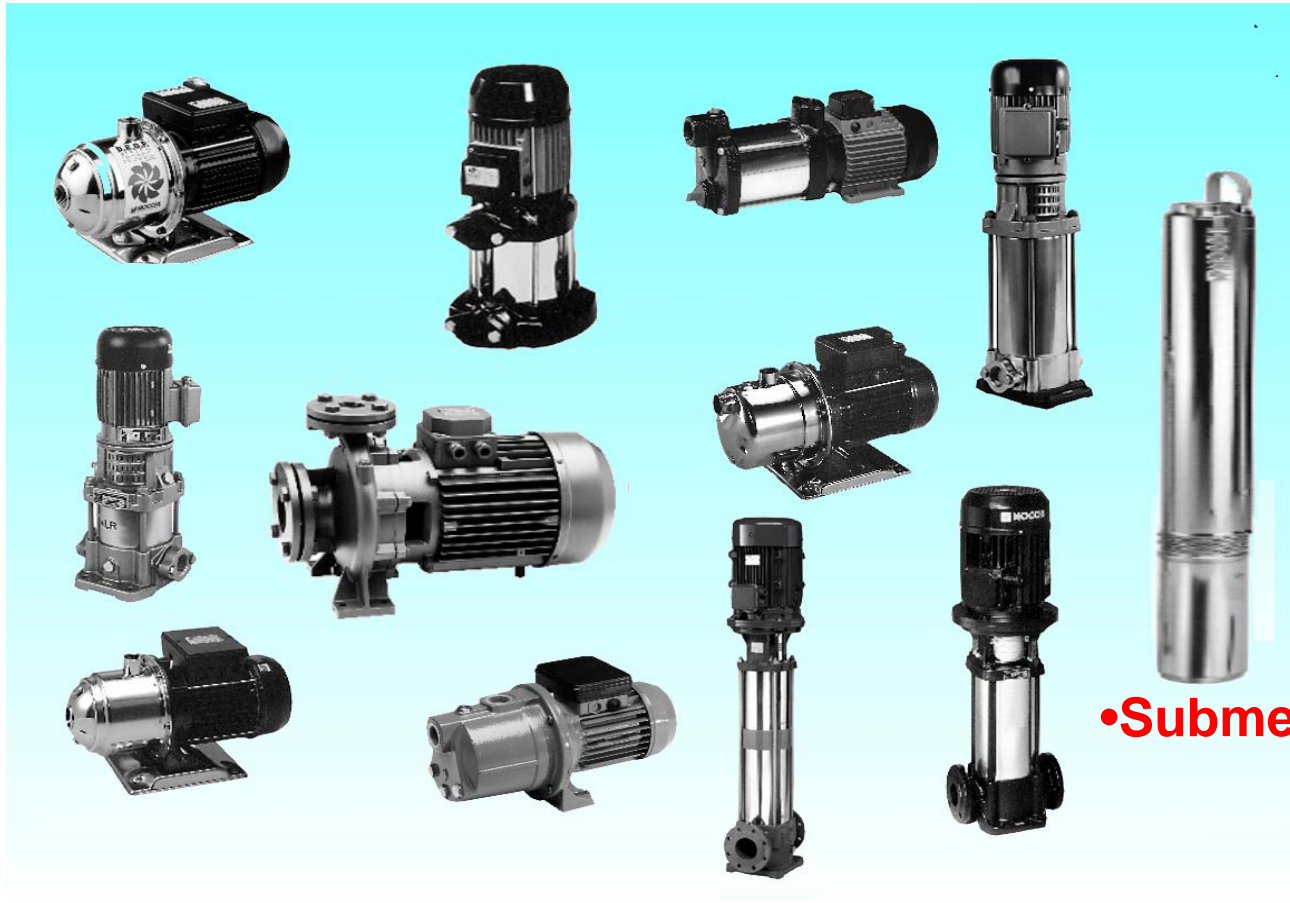

•With horizontal axis

•With vertical axis

•Submersible



NOCCHI[®]

Pentair Water

25/285 RamKhamHaeng 124 Rd., Sapansoong Bangkok 10240 Thailand Tel : 0 2728 2902 Fax : 0 2728 1779 www.tinamics.com

Tinamics Co.,Ltd.



CONTROL AND PROTECTION PANEL

Protections :

- Short circuited
- Overload
- Phase failure
- Water low level

Controls :

- Pressure or flow variation
- Starting alternative
- Starting sequence



NOCCHI[®]

Pentair Water

25/285 RamKhamHaeng 124 Rd., Sapsong Bangkok 10240 Thailand Tel : 0 2728 2902 Fax : 0 2728 1779 www.tinamics.com

Tinamics Co.,Ltd.



TINAMICS.CO.LTD

PRODUCTION RANGE



NOCCHI[®]
Pentair Water

25/285 RamKhamHaeng 124 Rd., Sapsong Bangkok 10240 Thailand Tel : 0 2728 2902 Fax : 0 2728 1779 www.tinamics.com

Tinamics Co.,Ltd.



PMX.20/VA - CB ...

PMS20/VA

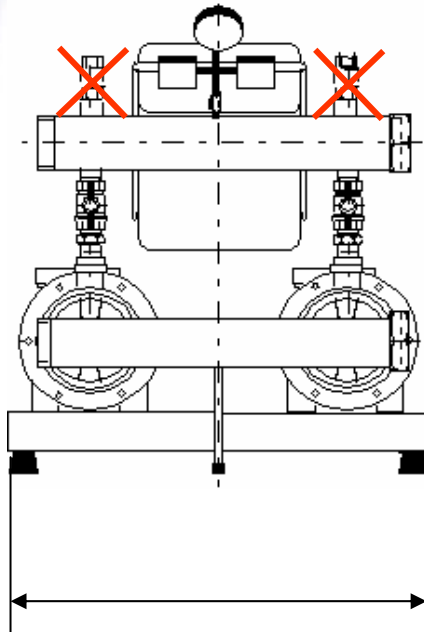

- *Riduction of dimension*
- *Low price*
- *efficiency*

PMXS20/VA

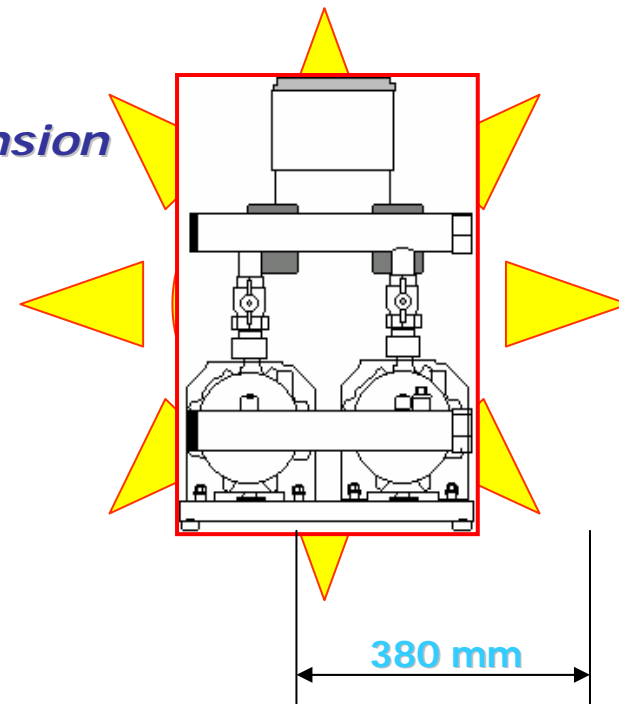

Nomenclature for booster sets

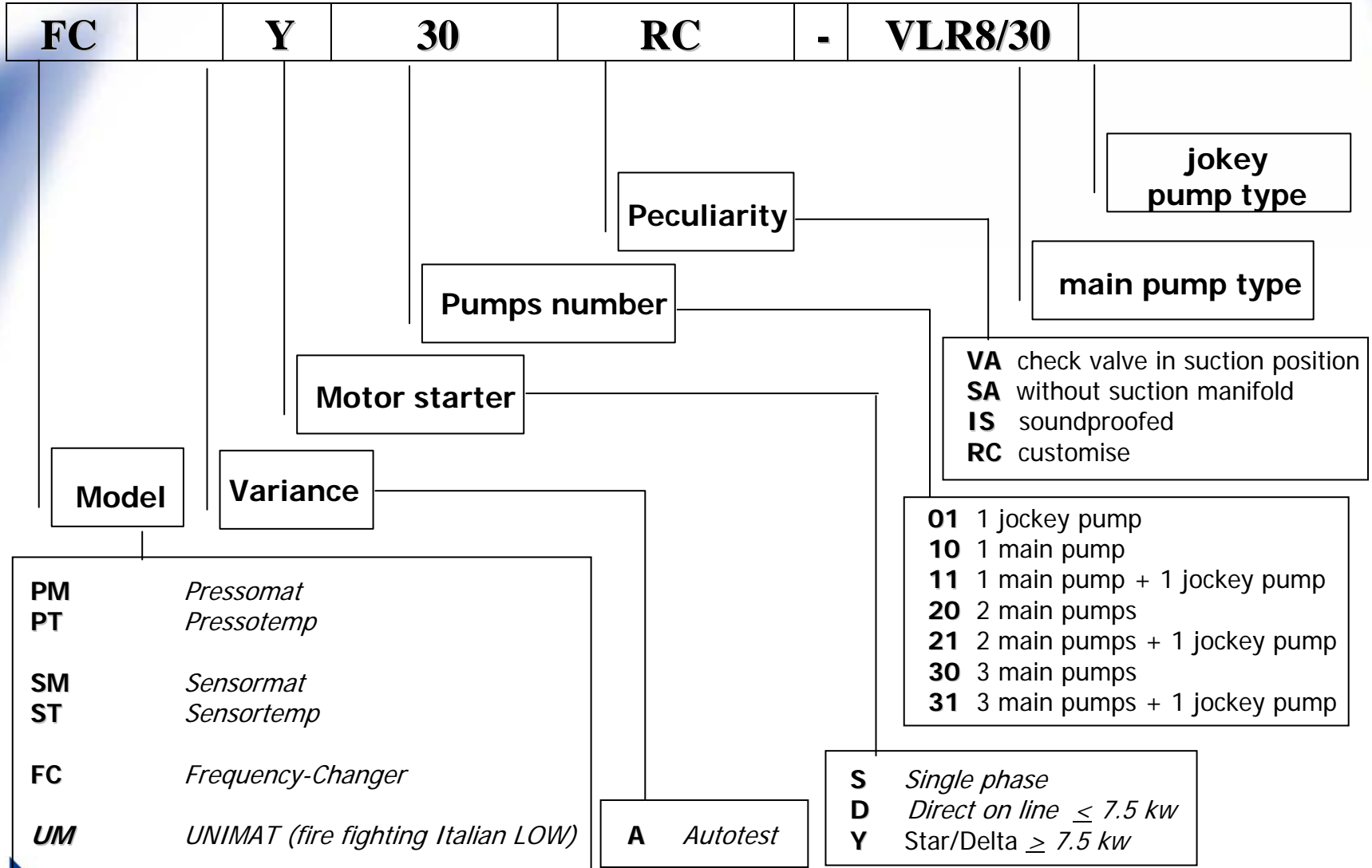

PMX.20/..

2 main horizontal pumps

CONSTANT SPEED

**CONTROLLED BY
PRESSURE SWITCHES**

**MANIFOLD MADE OF
GALVANIZED STEEL**



Type	Volt	Hz	Qmax	Kw
PMXS20/VA...	230	50	18	2x1,5
PMXS20/VA...	400	50	18	2x2

**B
O
O
S
T
E
R
S
E
T
S**

PMS20/..

2 main horizontal pumps

CONSTANT SPEED

**CONTROLLED BY
PRESSURE SWITCHES**

**MANIFOLD MADE OF
GALVANIZED STEEL**



**B
O
O
S
T
E
R
S
E
T
S**

Type	Volt	Hz	Qmax	Kw
PMS20/VA...	230	50	24	2x1,8
PMS20/VA...	400	50	24	2x2,7

Industrial line

PM.20/..

2 main pumps

CONSTANT SPEED

**CONTROLLED BY
PRESSURE SWITCHES**

**MANIFOLD MADE OF
STAINLESS STEEL
AISI304**



With 2 horizontal pumps



With 2 vertical pumps

PMS20/...	230	50	24	2x1,5
PM.20/...	400	50	480	2x37



Tinamics Co.,Ltd.

25/285 RamKhamHaeng 124 Rd., Sapansong Bangkok 10240 Thailand Tel : 0 2728 2902 Fax : 0 2728 1779 www.tinamics.com



**B
O
O
S
T
E
R
S
E
T
S**

WORKING DIAGRAM

PM.20/...

SENZA ATTIVAZIONE DELLE TEMPORIZZAZIONI

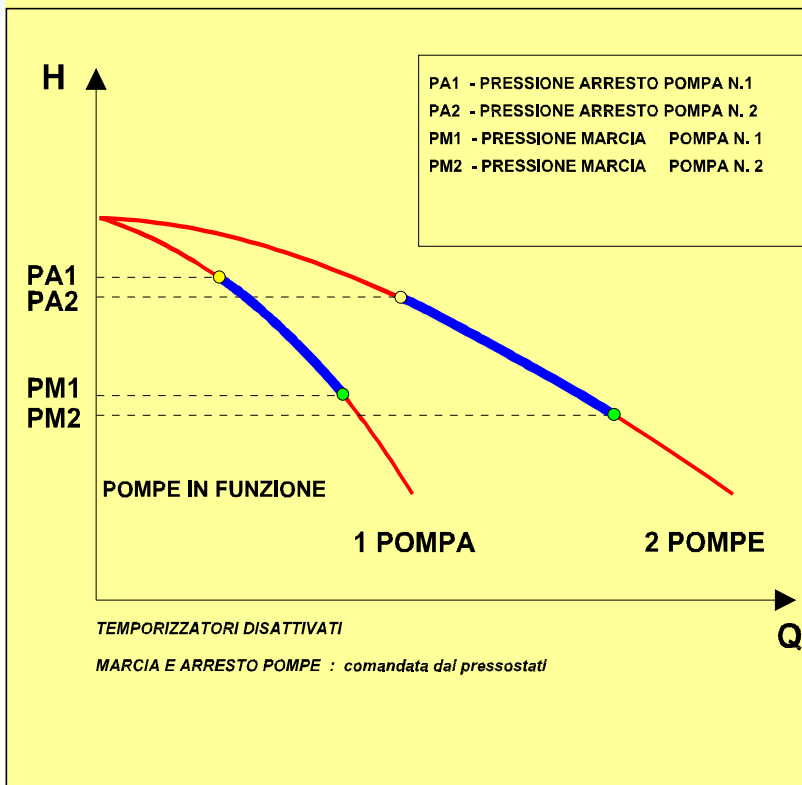

CON ATTIVAZIONE DELLE TEMPORIZZAZIONI

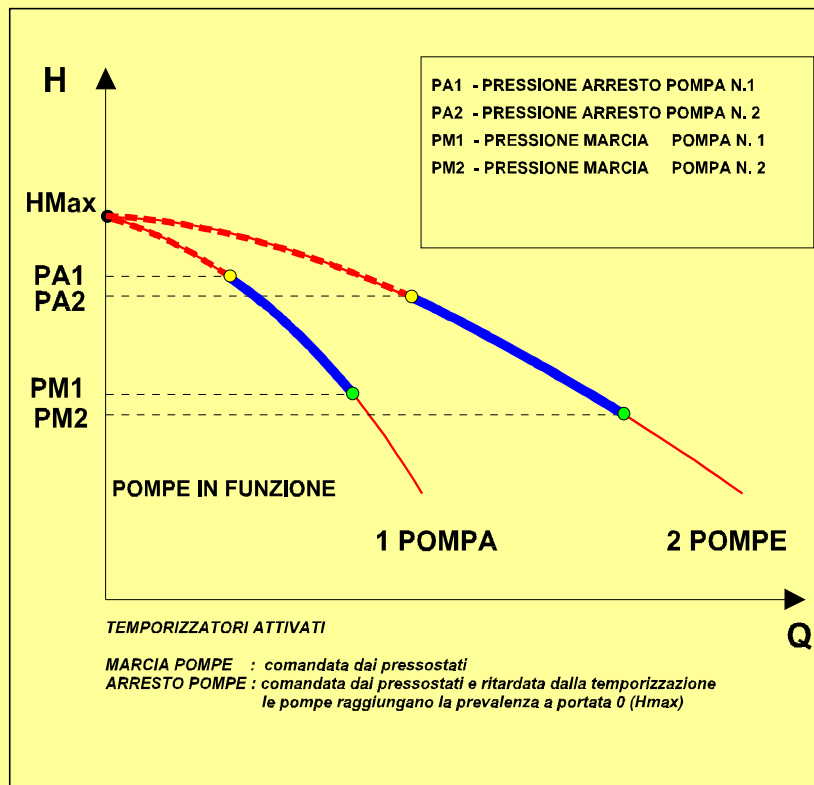

NOCCHI[®]
Pentair Water

25/285 RamKhamHaeng 124 Rd., Sapansoong Bangkok 10240 Thailand Tel : 0 2728 2902 Fax : 0 2728 1779 www.tinamics.com

Tinamics Co.,Ltd.



Industrial line

SM.21/..

2 main pumps one jockey pump

CONSTANT SPEED

**CONTROLLED BY
PRESSURE
TRANSDUCER**

**MANIFOLD MADE OF
STAINLESS STEEL
AISI304**



With 2 vertical pumps



With 2 horizontal pumps

Type	Volt	Hz	Qmax	Kw
SM.21/...	400	50	480	2x37+2

**B
O
O
S
T
E
R
S
E
T
S**



WORKING DIAGRAM

SM.21/...

SENZA ATTIVAZIONE DELLE TEMPORIZZAZIONI

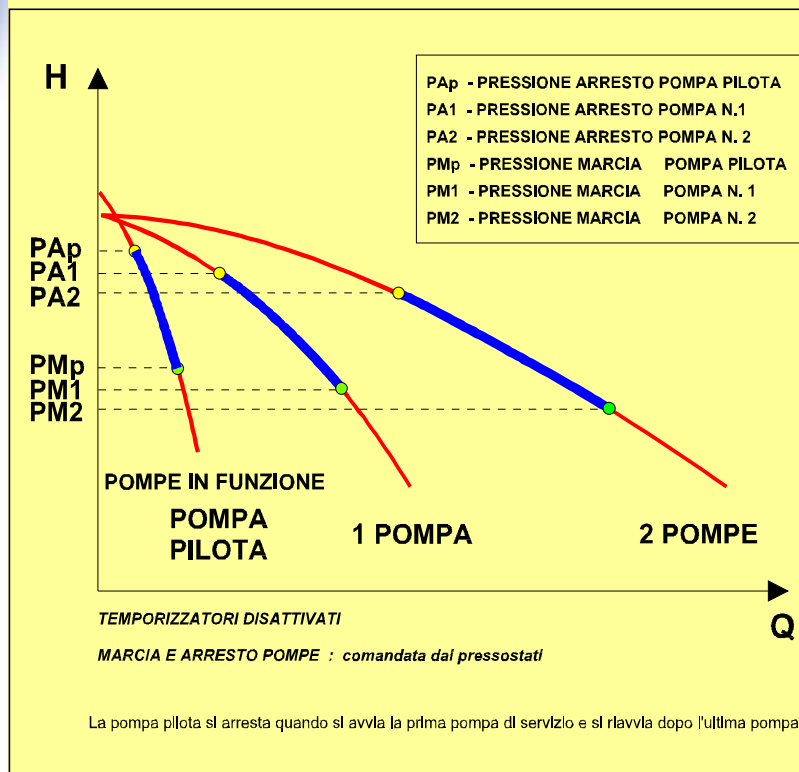

CON ATTIVAZIONE DELLE TEMPORIZZAZIONI

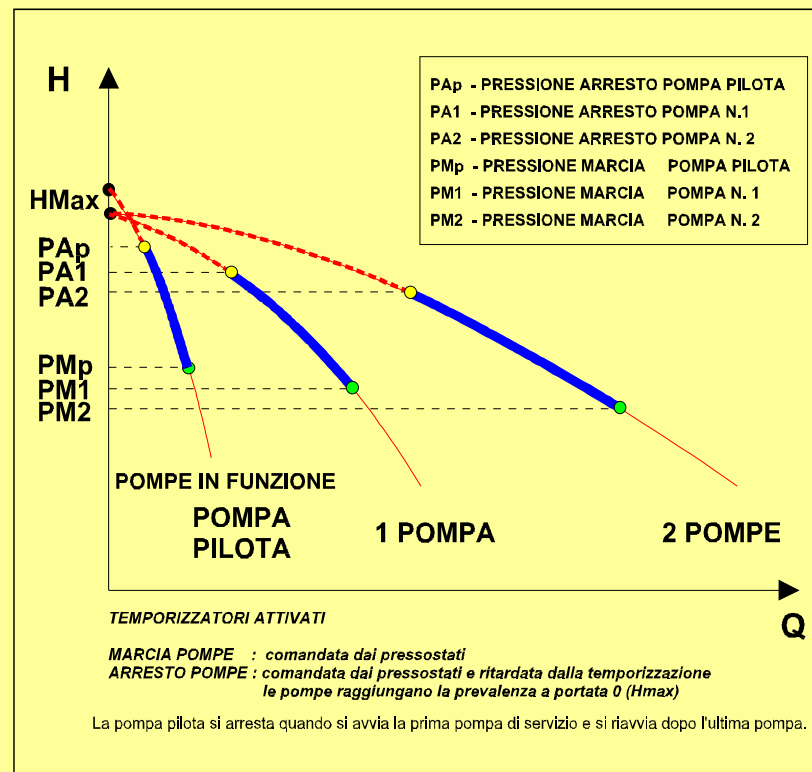

Industrial line

SM.30/..

3 main pumps

**B
O
O
S
T
E
R
S
E
T
S**



With 3 vertical pumps

CONSTANT SPEED

**CONTROLLED BY
PRESSURE
TRANSDUCER**

**MANIFOLD MADE OF
STAINLESS STEEL
AISI304**



With 3 horizontal pumps

Type	Volt	Hz	Qmax	Kw
SM.30/...	400	50	720	3x37



Tinamics Co.,Ltd.

25/285 RamKhamHaeng 124 Rd., Sapansoong Bangkok 10240 Thailand Tel : 0 2728 2902 Fax : 0 2728 1779 www.tinamics.com



WORKING DIAGRAM

SM.30/...

SENZA ATTIVAZIONE DELLE TEMPORIZZAZIONI

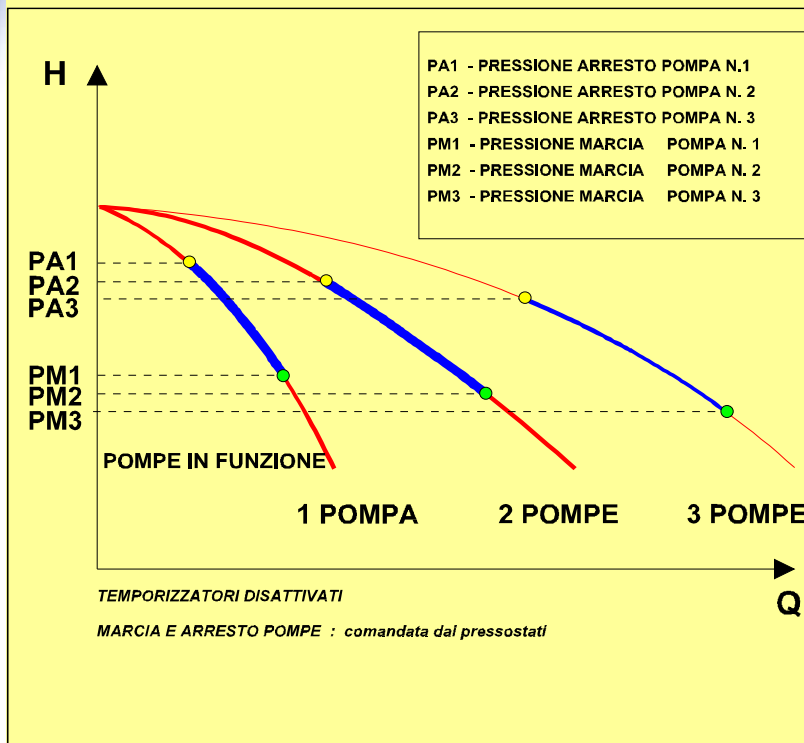

CON ATTIVAZIONE DELLE TEMPORIZZAZIONI

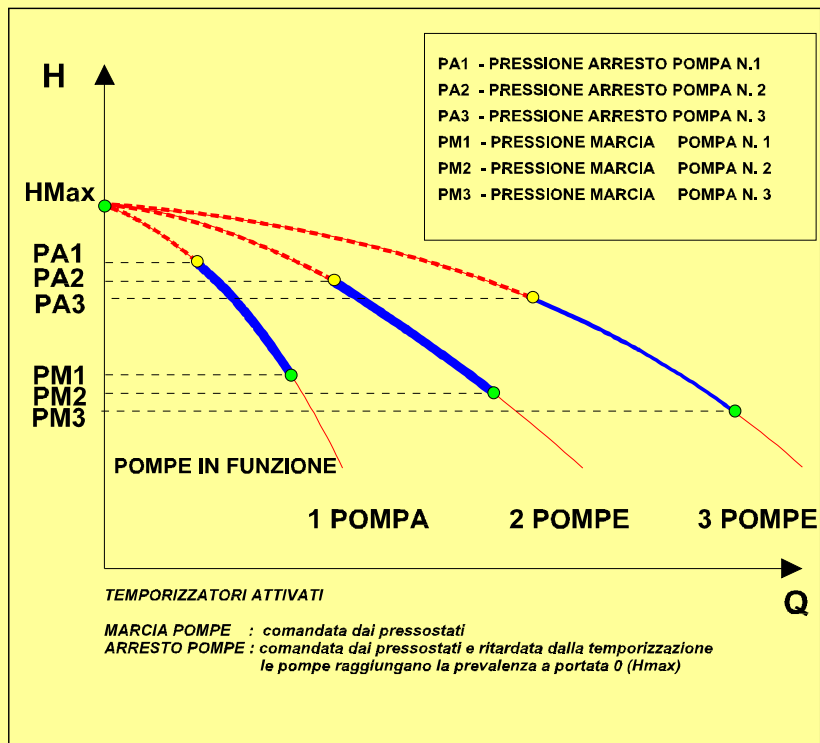

NOCCHI
Pentair Water

25/285 RamKhamHaeng 124 Rd., Sapansoong Bangkok 10240 Thailand Tel : 0 2728 2902 Fax : 0 2728 1779 www.tinamics.com

Tinamics Co.,Ltd.



SM.31/..

3 main pumps one jockey pump

CONSTANT SPEED

**CONTROLLED BY
PRESSURE
TRANSDUCER**

**MANIFOLD MADE OF
STAINLESS STEEL
AISI304**



With 3 vertical pumps



With 3 horizontal pumps

Type	Volt	Hz	Qmax	Kw
SM.31/...	400	50	720	3x37+2

**B
O
O
S
T
E
R
S
E
T
S**



WORKING DIAGRAM

SM.31/...

SENZA ATTIVAZIONE DELLE TEMPORIZZAZIONI

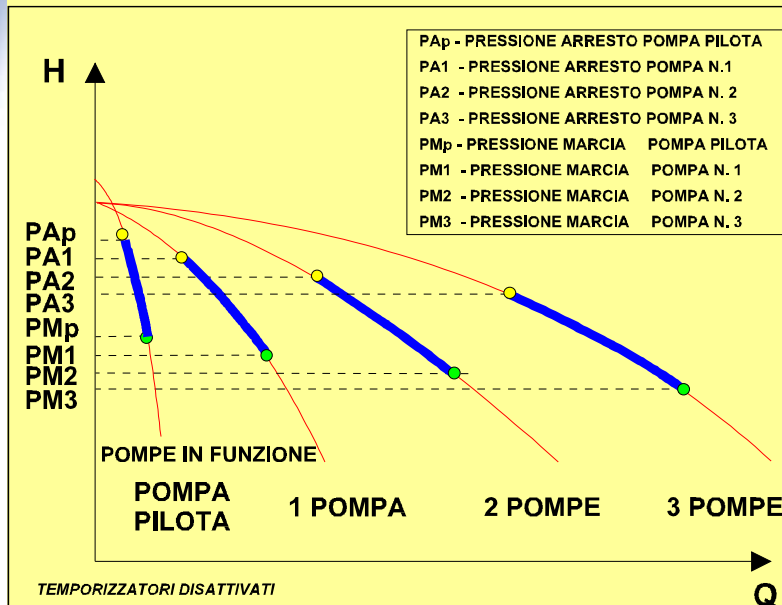

MARCIA E ARRESTO POMPE : comandata dal trasduttore di pressione attraverso la scheda con microprocessore.

La pompa pilota si arresta quando si avvia la prima pompa di servizio e si riavvia dopo l'ultima pompa.

CON ATTIVAZIONE DELLE TEMPORIZZAZIONI

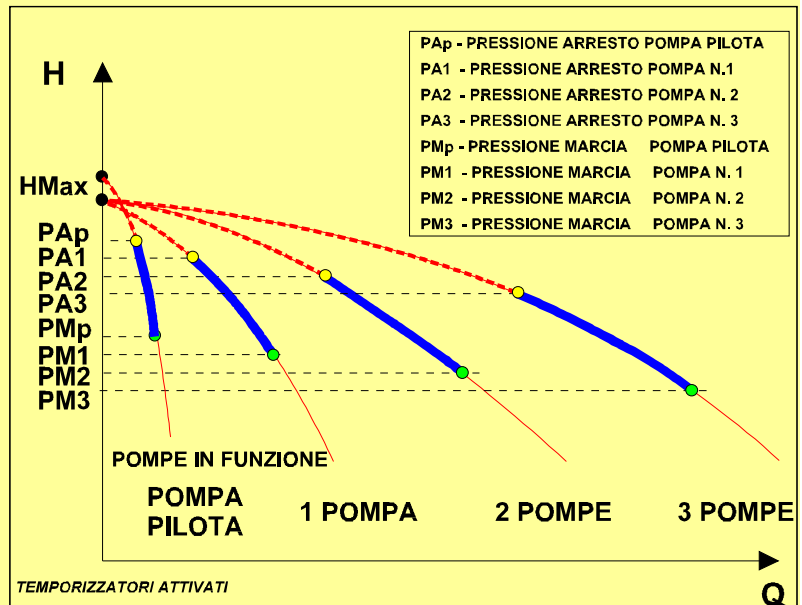

MARCIA POMPE : comandata dal trasduttore di pressione attraverso la scheda con microprocessore
 ARRESTO POMPE : comandata dal trasduttore di pressione attraverso la scheda con microprocessore con ritardo dovuto dalla temporizzazione richiesta.
 Le pompe raggiungono la prevalenza a portata 0 (Hmax)

La pompa pilota si arresta quando si avvia la prima pompa di servizio e si riavvia dopo l'ultima pompa.

Industrial line

FC.20/... FC.30/... FC.40/...

From 2 to 4 main pumps



VARIOUS SPEED

**CONTROLLED BY
PRESSURE
TRANSDUCER**

Type	Volt	Hz	Qmax	Kw
FC.20/...	400	50	144	2x15
FC.30/...	400	50	216	3x15
FC.40/...	400	50	288	4x15

**MANIFOLD MADE OF
STAINLESS STEEL
AISI304**

**B
O
O
S
T
E
R
S
E
T
S**



WORKING DIAGRAM

FC../...

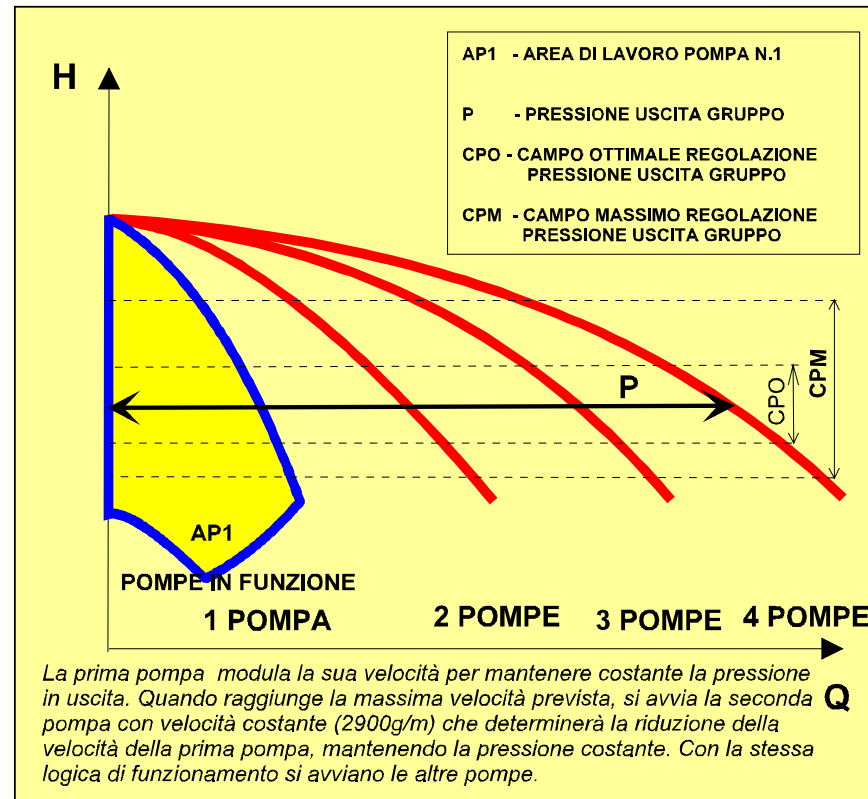

NOCCHI
Pentair Water

25/285 RamKhamHaeng 124 Rd., Sapansoong Bangkok 10240 Thailand Tel : 0 2728 2902 Fax : 0 2728 1779 www.tinamics.com

Tinamics Co.,Ltd.



Our electronic cards

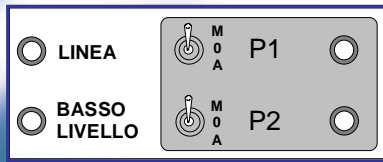

Type SM

For units with 2 pumps and pressure switch

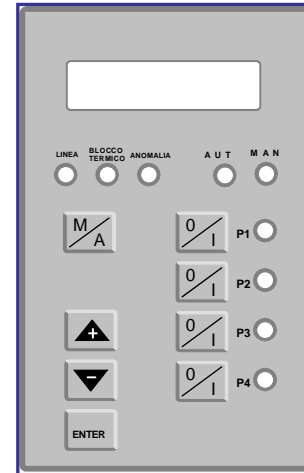

Type SD

For units up to 4 and pressure switch or electronic transducer

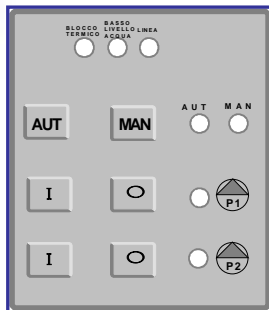

Type SA

For units with 2 pumps and pressure switch

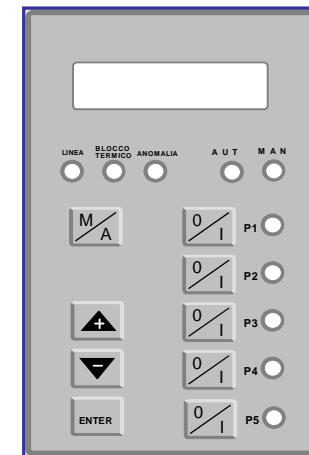

Type SI

For units up to 5 with electronic transducer and an inverter

...and..

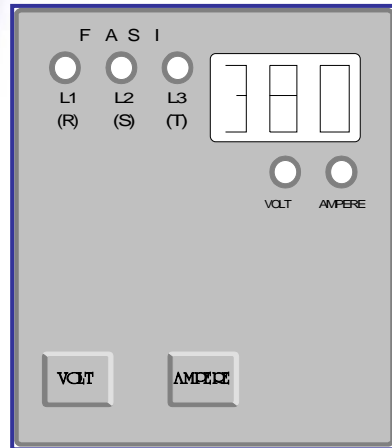

Keyboard for voltage and amperes measurement when you use pump up to 7.5 kw or Frequency Changer version



EXPORT SALES PROPOSALS

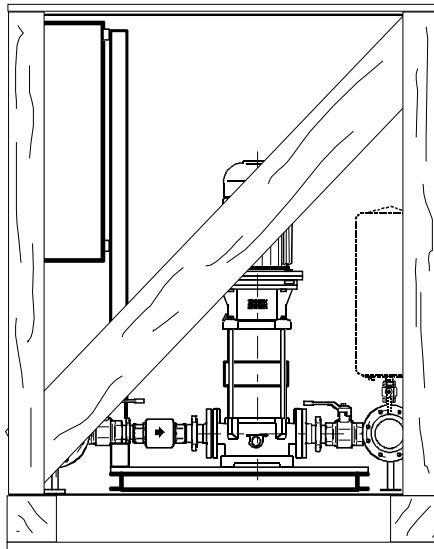

- MOUNTED AND TESTED BOOSTER SET
- WITH "CE" COMPLIANCE
- INSTALLATION AND OPERATING MANUAL
- ELECTRICAL AND DIMENSIONAL DRAWINGS



NOCCHI[®]

Pentair Water

25/285 RamKhamHaeng 124 Rd., Sapansoong Bangkok 10240 Thailand Tel : 0 2728 2902 Fax : 0 2728 1779 www.tinamics.com

Tinamics Co.,Ltd.

